

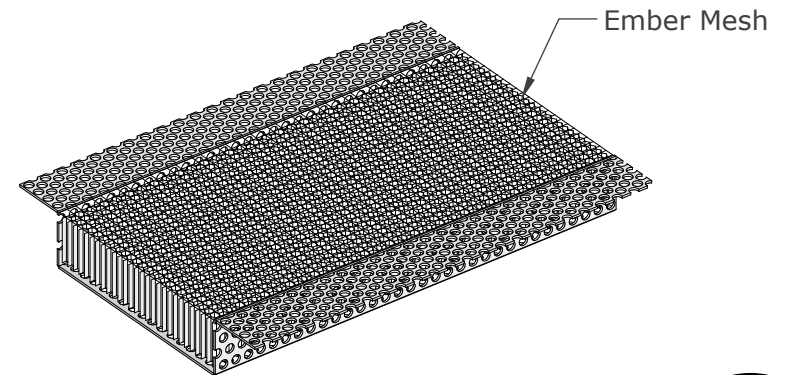

V2VENTS.COM (916) 652-7424 info@vulcanvents.com P.O. Box 1126 Loomis, CA. 95650

**For use to comply with IWUI, IBHS Wildfire Prepared Certification, California Chapter 7A\***

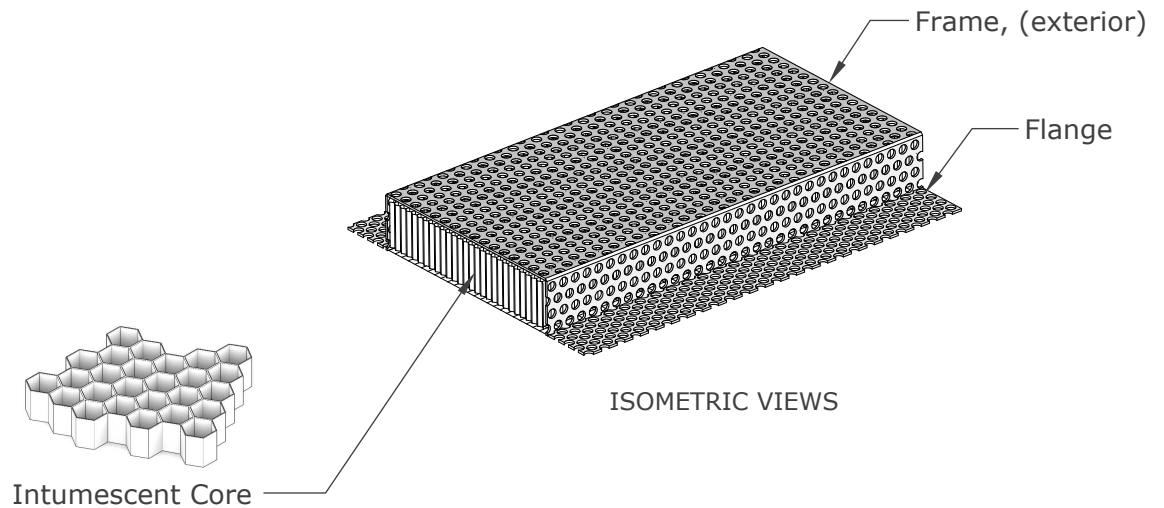
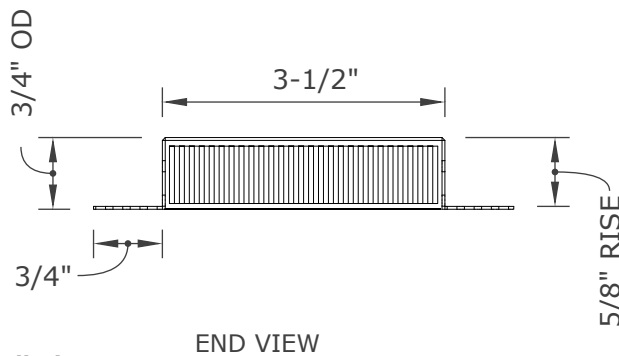
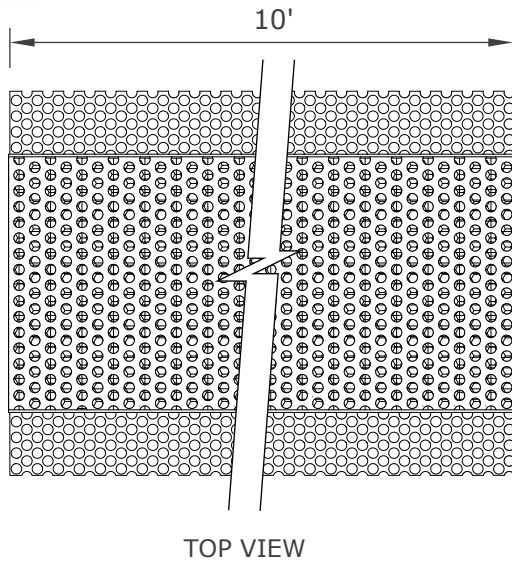

**Required Installation:**

Use **EverKem 814+ intumescent firestop caulking** or equivalent, BEHIND flanges.  
For application details and installation examples, please visit [www.V2Vents.com](http://www.V2Vents.com)

Proudly Manufactured By: **NEW CAL METALS INC.**

[www.newcalmetals.com](http://www.newcalmetals.com)

## FSVSC35120 PRODUCT SPECIFICATION & DATA SHEET

Model Description	<b>Continuous Vent</b>	Flange Type	<b>Standard</b>	Frame & Flange	<b>G90 Galvanized Perforated Steel (1/8" holes) - 24GA</b>
Model Number	<b>FSVSC35120</b>	NFVA	<b>168 sq. in.</b>	Intumescent Core	<b>5mm Hexagonal Matrix - Aluminum with intumescent coating</b>
Model Size	<b>3-1/2" x 120"</b>			Ember Mesh	<b>14 Mesh - 304 Stainless Steel</b>