

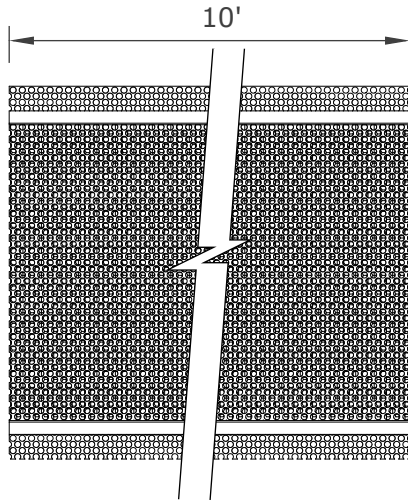

V2VENTS.COM (916) 652-7424 info@vulcanvents.com P.O. Box 1126 Loomis, CA. 95650

For use to comply with IWUI, IBHS Wildfire Prepared Certification, California Chapter 7A*



TOP VIEW

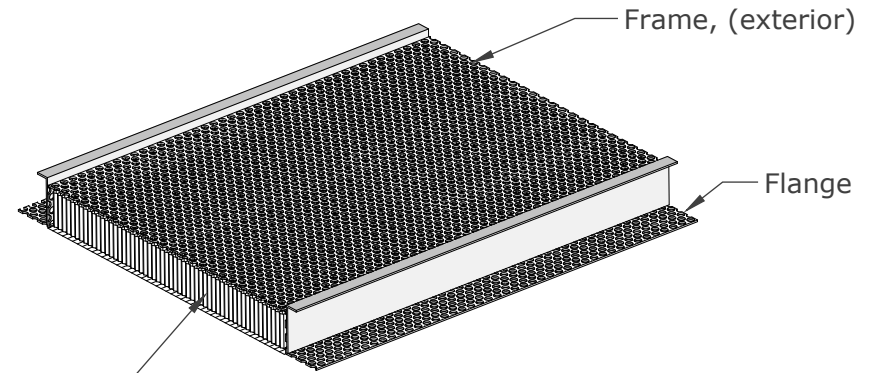

ISOMETRIC VIEWS

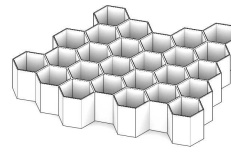

Intumescent Core

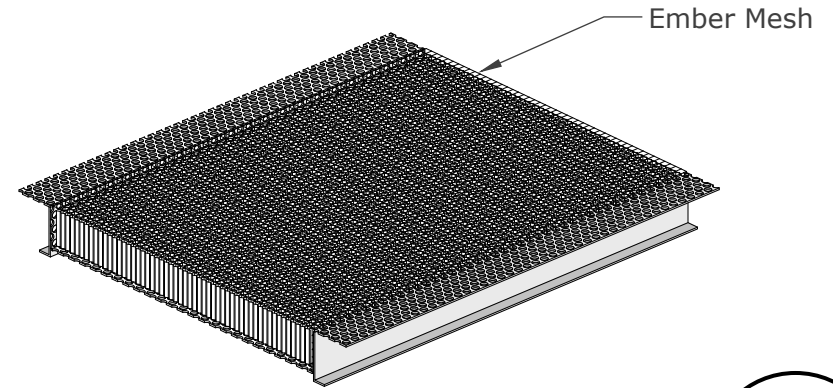

Ember Mesh

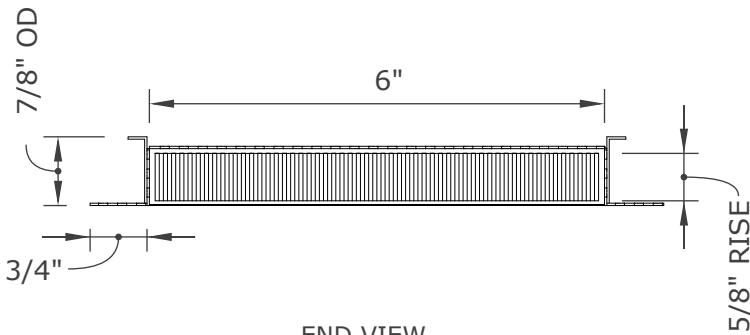

END VIEW

Required Installation:

Use **EverKem 814+ intumescent firestop caulking** or equivalent, BEHIND flanges.
For application details and installation examples, please visit www.V2Vents.com

Proudly Manufactured By: **NEW CAL METALS INC.**

www.newcalmetals.com

FSVSC6120SMC78 PRODUCT SPECIFICATION & DATA SHEET

Model Description	Continuous Vent	Flange Type	Stucco MilCor 7/8"	Frame & Flange	G90 Galvanized Perforated Steel (1/8" holes) - 24GA
Model Number	FSVSC6120SMC78	NFVA	288 sq. in.	Intumescent Core	5mm Hexagonal Matrix - Aluminum with intumescent coating
Model Size	6" x 120"			Ember Mesh	14 Mesh - 304 Stainless Steel